

1

2

3

4

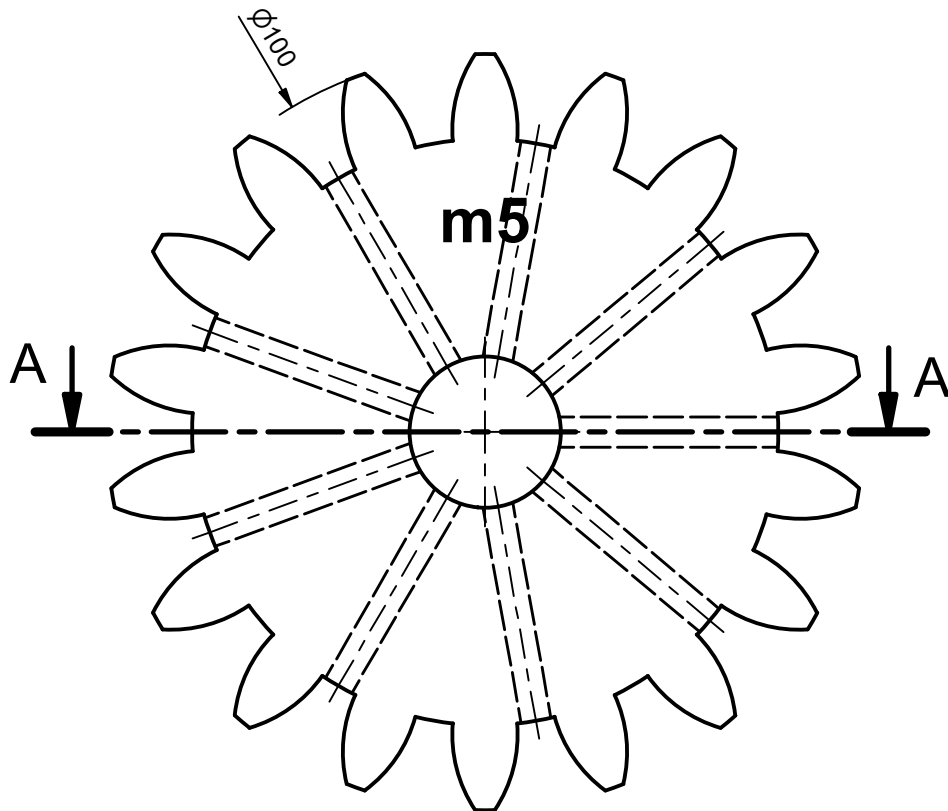

A-A

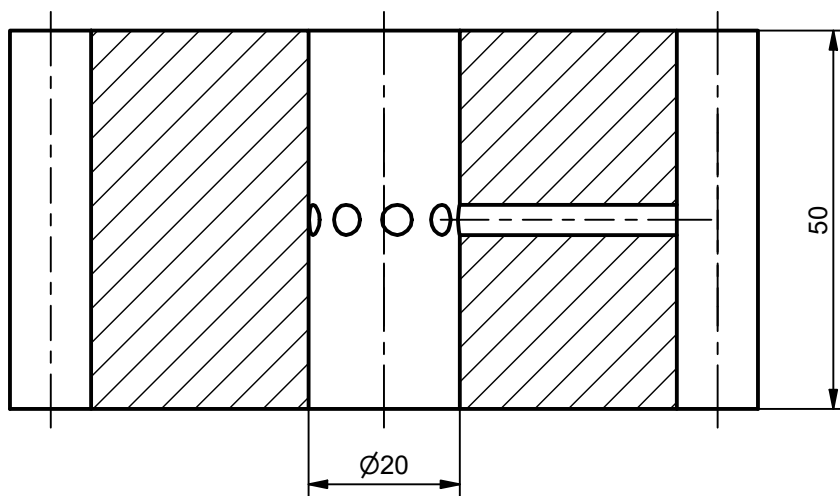

(1:2)

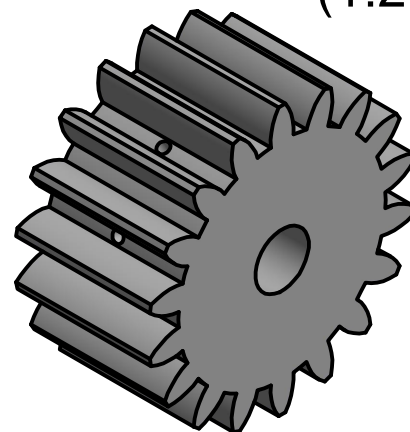

Modul/module	m	5
Zähne/teeth	z	18

Scale:	Date:	Material:	Description:	 <small>perma-tec GmbH & Co. KG Hammelburger Str.21 97717 EUERDORF / GERMANY</small> <small>Tel.: +49 9704 609-0 Fax: +49 9704 609-50 www.perma-tec.com</small>
1:1	12.04.2024	Filz 1004	Lubrication gear felt m5 straight toothing	
Size:	Revision / drawn:	Part No.	Schmierzahnrad Filz m5 Verzahnung gerade	
A4	a / jur	118684		