

**Modifica prodotti**

perma accessori e componenti di montaggio nuovi e modificati

**Numero PCN.:**

1506-01-00

**Data:**

2015/06/10

**Descrizione cambiamento:**

Il nuovo programma Heavy Duty (HD) richiede nuovi articoli accessori.

Alcuni dei nostri articoli accessori già esistenti sono stati sostituiti o modificati.

I nuovi accessori HD possono essere utilizzati per tutti i sistemi di lubrificazione perma a singolo punto.

Abbiamo preparato un catalogo nuovo (in aggiunta al nostro catalogo standard).

Il nuovo catalogo si chiama "**Industria pesante e delle miniere**" (articolo# 110197) e contiene il programma completo HD con tutti gli accessori.

**Dettagli:****Accessori modificati (il codice articolo non cambia!):**

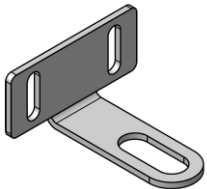
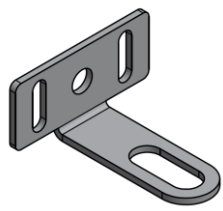

Nome accessorio	Cod.art.	Disegno vecchio	Disegno nuovo
<b>Supporto (Acciaio inox)</b>	104864		

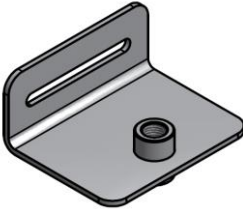
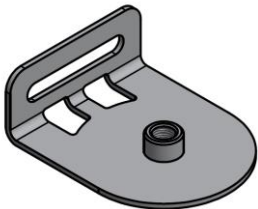
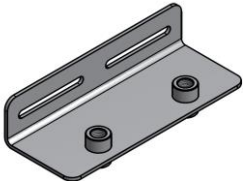
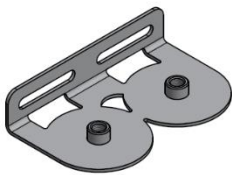
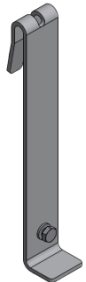
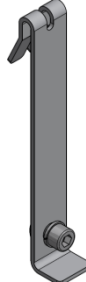
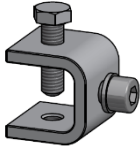
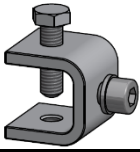
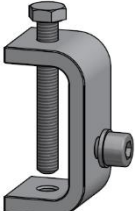

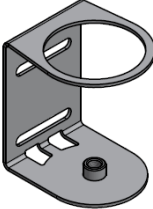

## - Accessori sostituiti (con codici articoli nuovi):

Accessori	Cod.art. DISMESSO	Cod.art. NUOVO	Disegno Vecchio	Disegno NUOVO
Supporto STAR Duty 1-punto G1/4i (acciaio inox)	104883	109663		
Supporto STAR Duty 2-punti G1/4i (acciaio inox)	104884	109667		
Staffa a gancio (acciaio inox)	104886	109959		
Morsetto di fissaggio 30 mm (acciaio inox)	104885	109957 (30 mm)		
Morsetto di fissaggio 65 mm (acciaio inox)		109958 (60 mm)		

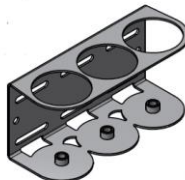
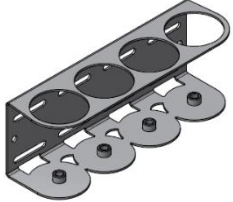
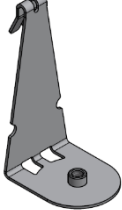
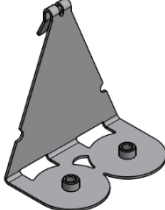
## - Accessori nuovi

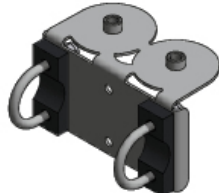
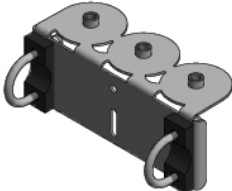
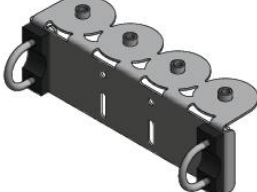
Nome accessorio	Cod.art.	Disegno
<b>Supporto CLASSIC, FUTURA, NOVA, FLEX 1-punto G1/4i (acciaio inox)</b>	109685	
<b>Supporto CLASSIC, FUTURA, NOVA, FLEX 2-punti G1/4i (acciaio inox)</b>	109686	
<b>Supporto CLASSIC, FUTURA, NOVA, FLEX per griglia di protezione 1-punto G1/4i (acciaio inox)</b>	109689	
<b>Supporto CLASSIC, FUTURA, NOVA, FLEX per griglia di protezione 2-punti G1/4i (acciaio inox)</b>	109690	
<b>Supporto STAR Duty 3-punti G1/4i (acciaio inox)</b>	109670	
<b>Supporto STAR Duty 4-punti G1/4i (acciaio inox)</b>	109673	

Accessori	Cod.art.	Disegno
<b>Supporto STAR Heavy Duty profilo C</b> <b>1-punto G1/4i (acciaio inox)</b>	109664	
<b>Supporto STAR Heavy Duty profilo C</b> <b>2-punti G1/4i (acciaio inox)</b>	108648	
<b>Supporto STAR Heavy Duty profilo C</b> <b>3-punti G1/4i (acciaio inox)</b>	109671	
<b>Supporto STAR Heavy Duty profilo C</b> <b>4-punti G1/4i (acciaio inox)</b>	109674	
<b>Supporto STAR Duty per griglia di protezione</b> <b>1-punto G1/4i (acciaio inox)</b>	109665	
<b>Supporto STAR Duty per griglia di protezione</b> <b>2-punti G1/4i (acciaio inox)</b>	109668	

Accessori	Cod.art.	Disegno
<b>Supporto STAR Duty su binario</b> <b>1-punto G1/4i (acciaio inox) incl. 2 forcelle a U</b>	110014	
<b>Supporto STAR Duty su binario</b> <b>2-punti G1/4i (acciaio inox) incl. 2 forcelle a U</b>	110015	
<b>Supporto STAR Duty su binario</b> <b>3-punti G1/4i (acciaio inox) incl. 2 forcelle a U</b>	110016	
<b>Supporto STAR Duty su binario</b> <b>4-punti G1/4i (acciaio inox) incl. 2 forcelle a U</b>	110017	
<b>Rubinetto di spurgo con valvola manuale</b> <b>G1/4i</b>	109684	
<b>Flangia di supporto STAR Gen 2.0 G1/4e x</b> <b>G1/4i (ottone / plastica) +</b> <b>Sicura per cappuccio di protezione STAR</b> <b>VARIO Heavy Duty</b>	109420 + 108606	
<b>Cappuccio di protezione STAR Heavy Duty</b> <b>250 (plastica)</b>	109999	

<b>Prodotti interessati:</b>
Accessori perma
<b>Data di attuazione:</b>
Immediata
<b>Osservazione:</b>
Vedere disegni allegati