

1

2

3

4

A

B

C

D

E

F

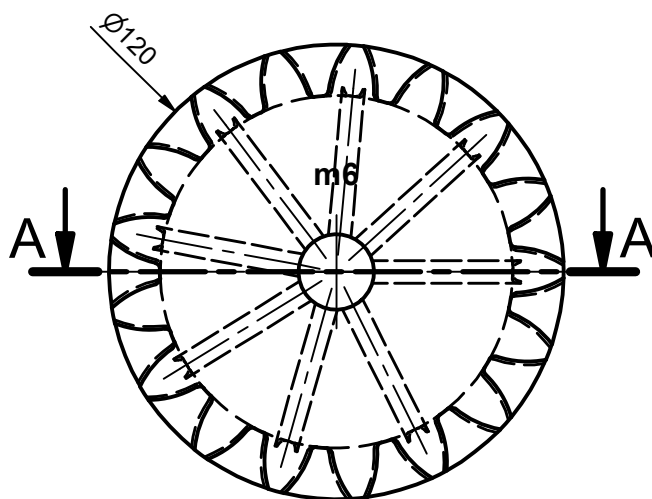

A-A

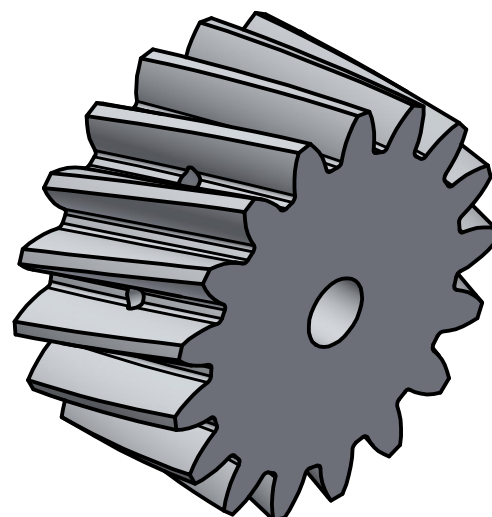
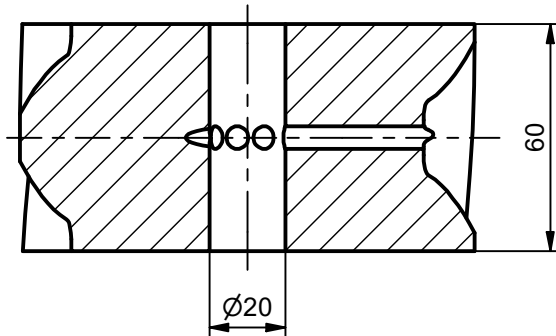

Modul/module	m	6
Zähne/teeth	z	17

Scale:	Date:	Material:	Description:
1:1	12.04.2024	Filz 1004	Lubrication gear felt m6 helical tooth left
Size:	Revision / drawn:	Part No.	Schmierzahnrad Filz m6 Verzahnung schräg links
A4	a / jur	118692	

perma

perma-tec GmbH & Co. KG
Hammelburger Str. 21
97717 EUERDORF / GERMANY

Tel.: +49 9704 609-0
Fax: +49 9704 609-50
www.perma-tec.com