

# perma PRO

Exemples de montage

Assembler toutes les connexions acier-acier avec Loctite® 243™ [Art. No. 110278].

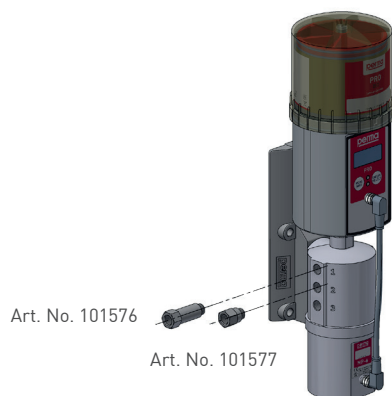





















perma PRO MP-6  
perma PRO C MP-6  
perma PRO LINE  
perma PRO C LINE



Art. No. 107629:  
6 x Art. No. 101570  
6 x Art. No. 101571  
4 x Art. No. 103288



Art. No. 101569

 Art. No. 111957	 Art. No. 101512   Art. No. 101515	 Art. No. 101496   Art. No. 104882  Art. No. 104853   Art. No. 104868   Art. No. 113864 (500 mm)  Art. No. 101549 (1000 mm)  Art. No. 101550 (1500 mm)   Art. No. 104868	 Art. No. 101502   Art. No. 116624   Art. No. 101555   Art. No. 116624
 Art. No. 116291 (14 mm) Art. No. 116292 (30 mm)		 Art. No. 104879  Art. No. 104875  Art. No. 104877  Art. No. 104876	

## Pièces de raccordement

Art. No.	Désignation
101576	Rallonge 16 mm G1/8e x G1/8i (nickelé laiton)
101577	Rallonge 36 mm G1/8e x G1/8i (nickelé laiton)
107629	Boîte d'accessoires MP-6 6 x Raccord G1/8e pour flexible eØ 8 mm droit (nickelé laiton) 6 x Raccord G1/8e pour flexible eØ 8 mm 90° - pivotant (nickelé laiton) 4 x bouchon de fermeture
101569	Flexible jusqu'à +100 °C eØ 8 mm x iØ 5 mm (PA) - pour PRO -
101496	Raccord G1/4e pour flexible eØ 8 mm droit (nickelé laiton)
111957	Raccord M6e pour flexible eØ 8 mm 90° - pivotant (nickelé laiton)
101512	Adaptateur pour flexible eØ 6 mm vers eØ 8 mm (nickelé laiton)
101515	Raccord M6e pour flexible eØ 6 mm 90° - pivotant (nickelé laiton)
116291	Rallonge 14 mm M6x0,75e x M6i (inox)
116292	Rallonge 30 mm M6x0,75e x M6i (inox)
104882	Manchon G1/4i (inox)
104853	Manchon G1/4i (laiton)
104868	Raccord à olive R1/4e pour eØ 8 mm droit (inox)
113864	Flexible jusqu'à + 260 °C eØ 11 mm x iØ 8 mm 500 mm (PTFE / inox)
101549	Flexible jusqu'à + 260 °C eØ 11 mm x iØ 8 mm 1000 mm (PTFE / inox)
101550	Flexible jusqu'à + 260 °C eØ 11 mm x iØ 8 mm 1500 mm (PTFE / inox)
101502	Raccord G1/4i pour flexible eØ 8 mm droit (nickelé laiton)
116624	Raccord G1/4i pour flexible eØ 8 mm droit (nickelé laiton)
101555	Flexible Heavy Duty jusqu'à +100 °C eØ 16 mm x iØ 9,5 mm (avec couche intérieure NBR renforcée en textile)
104875	Réducteur G1/8e x G1/4i (inox)
104876	Réducteur M6e x G1/4i (inox)
104877	Réducteur M8x1e x G1/4i (inox)
104879	Réducteur M10x1e x G1/4i (inox)

Assembler toutes les connexions acier acier avec Loctite® 243™ (Art. No. 110278).

Vous trouverez d'autres accessoires dans le catalogue perma ou sous [www.perma-tec.com](http://www.perma-tec.com)